



# ASSEMBLY INSTRUCTION 3110

1

## LIST OF ACCESSORIES

A		B		C		D	
M8	x4	M8*18	x4	8x445mm	x4	x1	
E							
40*40*2	x8						

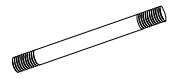
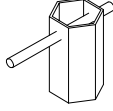
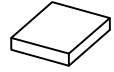
2

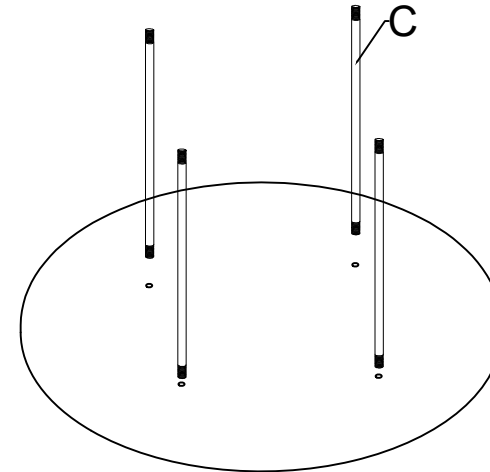

3

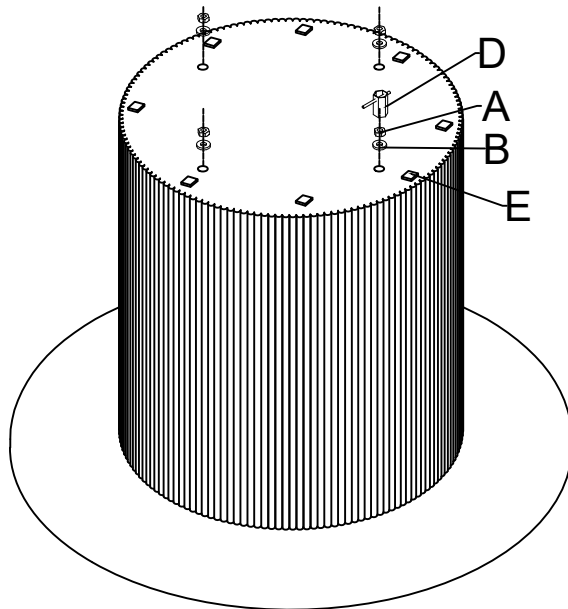

4

