

# ASSEMBLY INSTRUCTION

ITEM CODE 3315-1



**Ax01**



**Bx04**

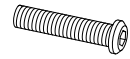

**Cx04**

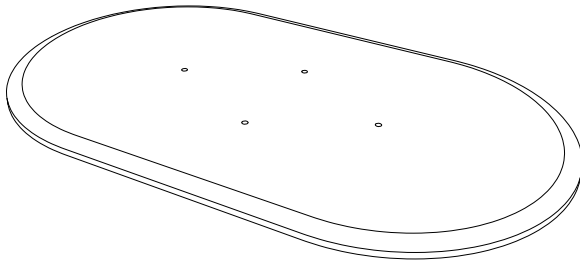

**Dx01**

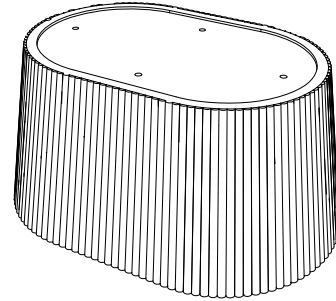

**Ex01**

## STEP - 01

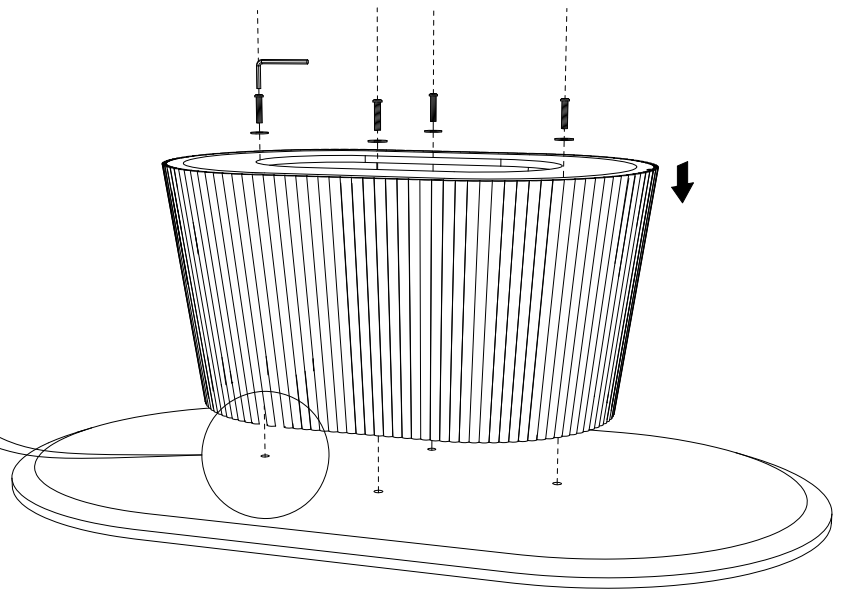
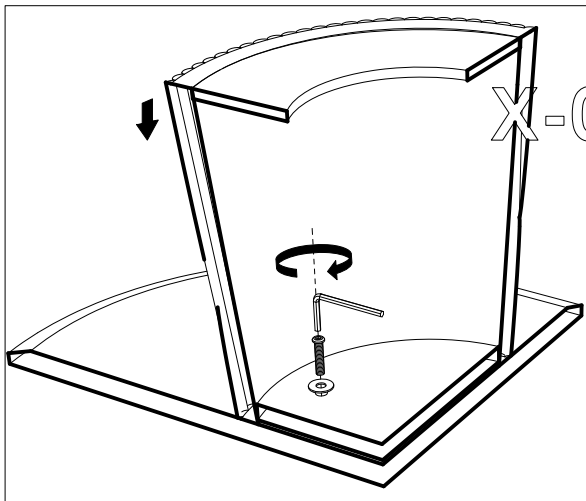

## Final - 02

