





# ASSEMBLY INSTRUCTION 3111

1

## LIST OF ACCESSORIES

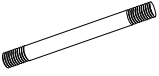
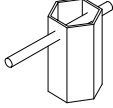
A		B		C		D	
M8	x4	M8*18	x4	8x365mm	x4	x1	
E							
40*40*2	x8						

2

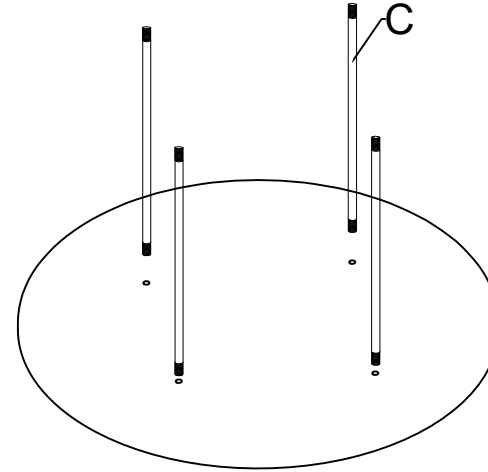

3

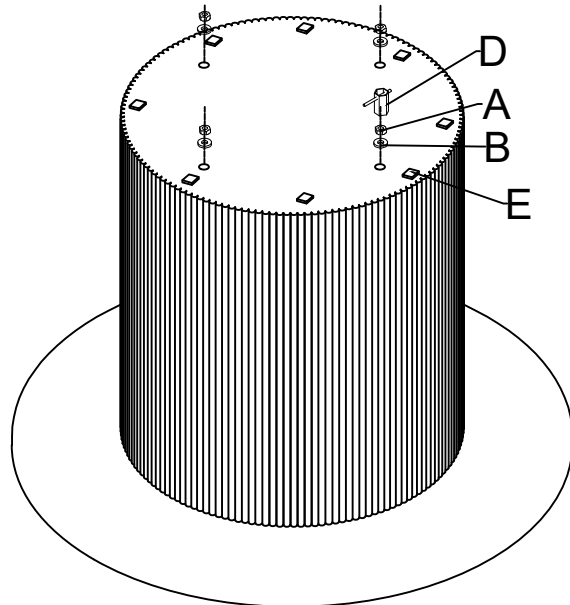

4

